

BACK TO BLACK

Firma Convex od 27 lat nieustannie inwestuje w wizję, elegancję i jakość swoich produktów. Wszystkie produkty wytwarzane są w zakładzie w Magoula w Atenach, w pionowo zintegrowanej jednostce, w której prowadzone są wszystkie fazy produkcji. Nasza nowa seria produktów wykorzystuje czarny kolor pokazując jego unikatową estetykę.

CERTYFIKATY



W listopadzie 2010 r. **CONVEX SA** uzyskał certyfikat za wdrożenie własnego systemu jakości zgodnie z wymaganiami normy **EN ISO 9001: 2008**. Certyfikat został wydany przez **TUV HELLAS**, znaną na całym świecie firmę, z wiarygodności swojej pracy.



CONVEX próbując zapewnić jeszcze większą jakość swoich produktów korzysta z zewnętrznych certyfikowanych laboratoriów, które wykonują takie testy jak: test odporności w kabinie solnej zgodnie z **EN 1670: 2007** „Okucia budowlane. Odporność na korozję. Wymagania i metody badań.”



CONVEX współpracuje z włoskim laboratorium **LAPI spa** w temacie testów przeciwpożarowych klamek zgodnie z normą **EN 1634-2: 2008** – „Badania odporności ogniowej i dymoszczelności zestawów drzwiowych i żaluzjowych, otwieralnych okien i elementów okuć budowlanych.”



KLAMKI
DRZWIOWE

MODEL 2405

www.convexdesign.pl

BACK TO BLACK

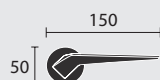

POZOSTAŁE OPCJE KOLORYSTYCZNE



Chrom



Nikiel Satyna



Chrom Satyna



Mosiądz Satyna

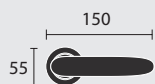

POZOSTAŁE OPCJE KOLORYSTYCZNE



Nikiel Satyna



Chrom Satyna

MODEL 2165

www.convexdesign.pl

BACK TO BLACK



POZOSTAŁE OPCJE KOLORYSTYCZNE



Nikiel Satyna



Chrom Satyna

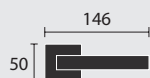

POZOSTAŁE OPCJE KOLORYSTYCZNE



Nikiel Satyna



Chrom Satyna

MODEL 2015

www.convexdesign.pl

BACK TO BLACK



POZOSTAŁE OPCJE KOLORYSTYCZNE



Chrom / Czerwony



Chrom / Nikiel Satyna



Nikiel Satyna / Biały

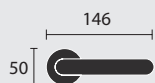

POZOSTAŁE OPCJE KOLORYSTYCZNE



Chrom Satyna



Nikiel Satyna



Chrom



MODEL 2195 Miedź / Biały



MODEL 2195 Chrom / Czarny Matowy



MODEL 2195 Chrom / Biały

MODEL 1725

www.convexdesign.pl

BACK TO BLACK

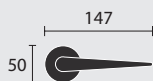

POZOSTAŁE OPCJE KOLORYSTYCZNE

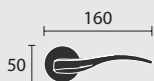

POZOSTAŁE OPCJE KOLORYSTYCZNE



Mosiądz Antyczny



Nikiel Satyna



Chrom Satyna

MODEL 1605

www.convexdesign.pl

BACK TO BLACK

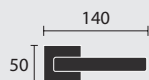

POZOSTAŁE OPCJE KOLORYSTYCZNE



Nikiel Satyna



Chrom Satyna



POZOSTAŁE OPCJE KOLORYSTYCZNE



Chrom Satyna



Nikiel Satyna

MODEL 1535

www.convexdesign.pl

BACK TO BLACK

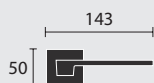

POZOSTAŁE OPCJE KOLORYSTYCZNE



Nikiel Satyna



Chrom Satyna



Mosiądz Antyczny

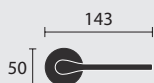

POZOSTAŁE OPCJE KOLORYSTYCZNE



Nikiel Satyna



Chrom Satyna



Chrom

MODEL 1505

www.convexdesign.pl

BACK TO BLACK

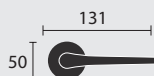

POZOSTAŁE OPCJE KOLORYSTYCZNE



Nikiel Satyna



Chrom Satyna



Chrom



Mosiądz Satyna



POZOSTAŁE OPCJE KOLORYSTYCZNE



Chrom Satyna



Nikiel Satyna



Chrom



Grafit Matowy

MODEL 1145

www.convexdesign.pl

BACK TO BLACK

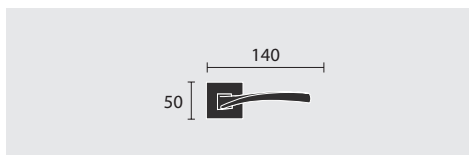

POZOSTAŁE OPCJE KOLORYSTYCZNE

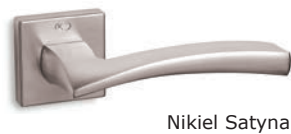



POZOSTAŁE OPCJE KOLORYSTYCZNE



Chrom Satyna



Nikiel Satyna



Biały Matowy

MODEL 745

www.convexdesign.pl

BACK TO BLACK

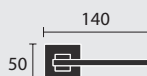

POZOSTAŁE OPCJE KOLORYSTYCZNE



Nikiel Satyna / Chrom



Mosiądz Matowy / Mosiądz



MODEL 1215 Czarny Matowy / Chrom



MODEL 1215 Nikiel Satyna / Chrom



POCHWYTY
I GAŁKI

MODEL 785

www.convexdesign.pl

BACK TO BLACK



POZOSTAŁE OPCJE KOLORYSTYCZNE



Chrom Satyna



Nikiel Satyna



Chrom



INOX
304

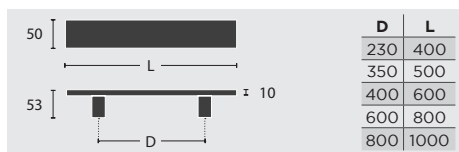

INOX
304

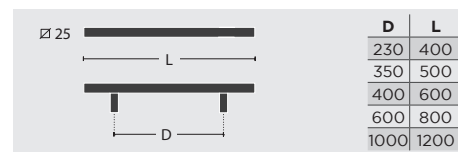

MODEL 1127



INOX
304

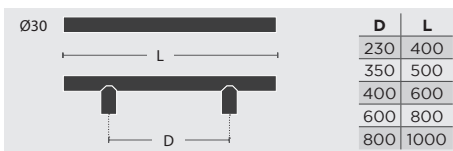

MODEL 1137

BACK TO BLACK



ALUMINIUM

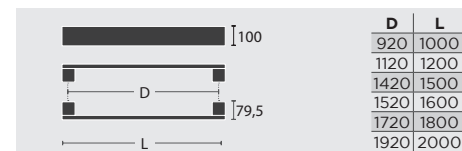



ALUMINIUM

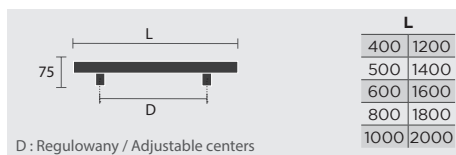

ALUMINIUM

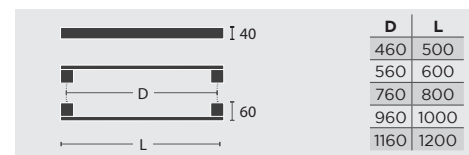



MODEL 987

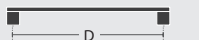
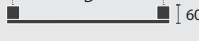
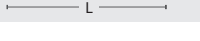

Czarny Matowy / Chrom

ALUMINIUM





	I 40		
	D	L	
	460	500	
	560	600	
	760	800	
	960	1000	
	1160	1200	

MODEL 919

BACK TO BLACK

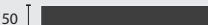

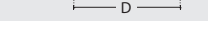
INOX 304

	50			
	D	L	D	L
	230	400	1000	1200
	350	500	1200	1400
	400	600	1400	1600
	600	800	1600	1800
	800	1000	1800	2000

MONTAŻ

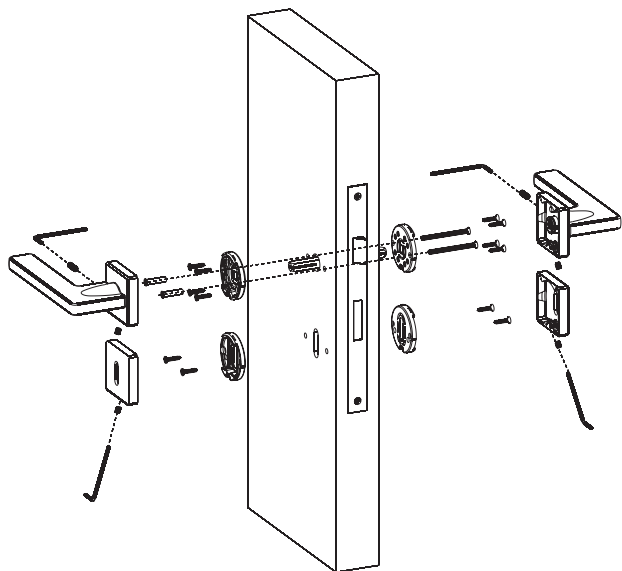

MONTAŻ KLAMKI NA ROZECIE

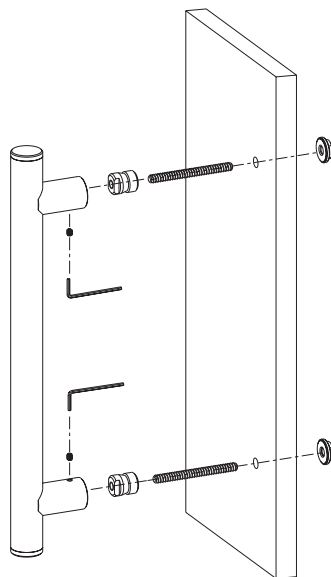

MONTAŻ POCHWYTU
JEDNOSTRONNEGO
NA PRZESTRZAŁ

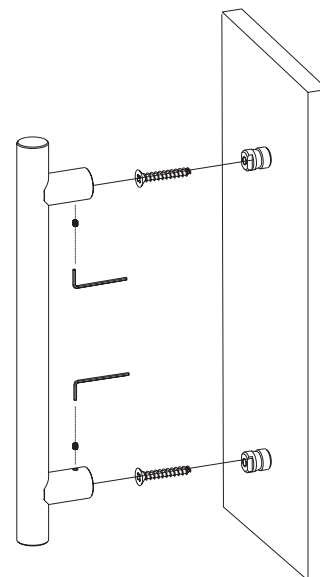

MONTAŻ POCHWYTU
JEDNOSTRONNEGO
NA DREWNOWKRĘT

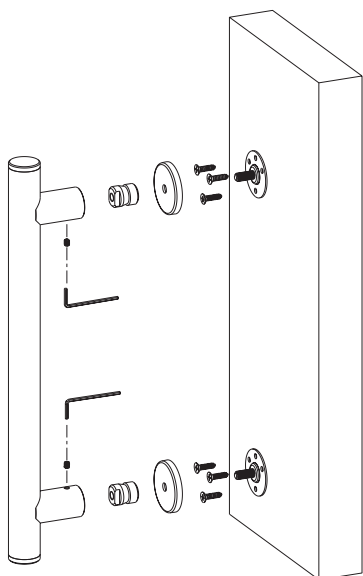

MONTAŻ POCHWYTU JEDNOSTRONNEGO PRZY UŻYCIU ROZETY
STABILIZUJĄCEJ

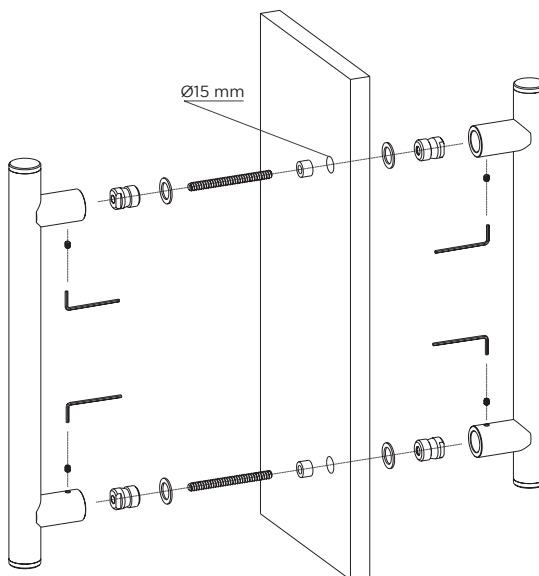

MONTAŻ POCHWYTU DWUSTRONNEGO
DO DRZWI SZKLANYCH

 **DOOR HANDLES MADE IN GREECE**

Rootkin

ROOTHKIN Sp. z o.o.
ul. Radoszowska 46
41-707 Ruda Śląska
T: +48 32 248 7008
F: +48 32 248 7008
M: +48 798 478 698

zamowienia@roothkin.pl

www.roothkin.pl

www.convexdesign.pl

 **CONVEX**[®]
HANDLES KNOBS DESIGN & PRODUCTION